

# Automatic Measurement System for Car Audio Applications

Angelo Farina (\*), Emanuele Ugolotti (\*\*)

(\*) Dipartimento di Ingegneria Industriale, Università di Parma,  
Via delle Scienze - 43100 PARMA - tel. +39 521 905854 - fax +39 521 905705  
E-MAIL: farina@pcfarina.eng.unipr.it - HTTP://pcfarina.eng.unipr.it

(\*\*) ASK Automotive Industries, via Fratelli Cervi n. 79, 42100 Reggio Emilia  
tel. +39 0522 388311 - fax. 0522 388499 - E-MAIL: tec\_ask@sirnet.it

## Abstract

The paper describes a new measurement system for the evaluation of the objective performances of a car audio apparatus. The system makes use of a 4-channels sound board fitted in a low-cost PC, which drives separately the 4 loudspeaker sections of the car. The excitation signal is a periodic maximum length sequence. The response of the system is sampled simultaneously with 2 binaural dummy heads.

The complete test takes less than 1 minute, thanks to a software specifically developed for this task.

## 1. Introduction

In this paper a new automated measured system is described. It was specifically developed for fast, accurate characterisation of the sound systems in cars.

The car-audio sound systems are typically subdivided in 4 separate sections, corresponding to the two sides (left and right) and to the front/back placement of the loudspeakers. A complete characterisation can be obtained only measuring separately the acoustic response of each section; after this, the behaviour of the sound system when all the channels are being used together can be derived mathematically, both for the hypothesis of completely independent feeds, or for (partially) coherent signals.

The basis for the measurement is a software implementation of the Maximum Length Sequence technique [1], which allows for the determination of the Impulse Response between each input channel and each measurement microphone. Typically two dummy heads equipped with binaural microphones are used, placed one at the driver's seat, the other at the passenger seat behind the driver: so 16 impulse responses are measured.

From the measured impulse responses a lot of objective parameters can be obtained: steady state frequency response, reverberation time, inter-aural cross-correlation and many others. Furthermore, they can be used as numerical filters in a convolution process, making it possible to listen at music or other signals, as if they were played inside the car. This is great for subjective assessment of the sound quality of the system.

In the following, a brief explanation of the mathematical theory employed for the measurement system is first given. Then the actual hardware and software implementation is described in detail. The performances of the system have been checked by comparison with existing instrumentation, and the calibration data are presented. Some examples of measurements made on different cars are shown as example.

## 2. Theory

The basic theory of MLS measurement systems is well known and documented [1,2,3].

This technique is widely employed for laboratory measurement of loudspeaker's performances, or for room acoustics characterization, but is not commonly employed for the measurements of the sound field inside a car, where systems originally intended for noise assessment are still in wide use.

The main difference from these two measurement philosophies is the emphasis given to the phase-related quantities. Traditional real-time analyzers or computer-based measurement systems, which were intended for noise analysis, usually compute 1/3 octave spectra without any phase information. So it is difficult to predict the sound field which will result by the simultaneous operation of multiple sound sources, generating highly correlated signals, because the interference cannot be reconstructed properly, and only an energy summation can be done. In cars, usually, the frequency region in which the acoustical resonances of the volume are important is much wider than in large rooms, and only at very high frequency a statistical energy analysis approach is satisfactory.

The impulse response, instead, contains detailed information both on the amplitude and phase of the system's response. From it, it is easy also to observe how much the resonant modes are damped. Apparently the same information could be obtained also with traditional FFT analyzers, but in practice very often these instruments do not have the capability to measure with very long FFT frames, so that if an high sampling rate is employed for covering the whole frequency range, the frequency resolution is too coarse at low frequency and the risk of severe time aliasing occurs (this happens if the FFT frame is shorter than the whole length of the acoustic decay inside the compartment).

The measurement with the MLS technique consists of two logical parts: generation of the excitation signal and deconvolution of the system's impulse response from the raw data sampled at its output.

The MLS excitation signal is well known since at least two decades [1,2,3]: it is a binary sequence, in which each value can be simply 0 or 1, obtained by a shift register as the one shown in fig. 1. The obtained signal is periodic, with period of length L given by:

$$L = 2^{N-1} \quad (1)$$

in which N is the number of slots in the shift register, also called the order of the MLS sequence. Thus an order N=16 means a sequence with a period of 65535 samples. Fig. 2 reports an example of an MLS signal of order 5.

Another very important point is the position of the tap inside the shift register: it is possible to generate MLS sequences also with multiple taps, and the position of the taps influences the behavior of the sequence, particularly when it is used for the excitation of systems which are not perfectly linear. The work of Vanderkooy [4] suggests that some sequences are better than others, reporting a list of known taps position which works reliably for various orders of the MLS sequence.

Older MLS systems were based on hardware shift registers for the generation of the excitation signal, but in this case a completely software implementation allows for the creation of MLS signals of any order and with arbitrary taps positions. Furthermore, the software implementation allows for the creation of pre-filtered MLS signals, following the original suggestion of Mommertz [5]. The creation of such pre-filtered signals is useful for compensating the uneven frequency responses of some elements of the measurement chain,

such as the microphones, or for improving the S/N ratio in certain frequency bands: more details on how to use this technique along with the efficient creation of inverse filters are given in [6].

In any case, the response of the system is sampled simultaneously with the generation of the excitation signal, and the wanted impulse response is obtained by cross-correlation of the excitation signal with the system's response. This can be made very efficiently (and with very little computational noise) with the well known Fast Hadamard Transform (FHT), as originally suggested by Alrutz [1], and clearly explained by Ando [2] and Chu [3]. The Ando formulation was employed here. The process is very fast, because the transformation happens "in place", and requires only addition and subtractions. The computations are done in floating point math, and the computed IR is then converted in 16-bit integer format by scaling to a pre-defined scale factor, so that the absolute amplitude information is preserved.

This measurement procedure solves the problems already encountered with other software MLS implementations [6], where both the absolute time delay and amplitude of the measured impulse responses were lost: in fact, in car audio applications it is important to maintain the information of the absolute delay and amplitude, for making it possible to combine properly the responses of the various loudspeakers.

### **3. Hardware Implementation**

The practical implementation of the measurement system was possible thanks to a multi-channel sound editing software (Cool Edit Pro), loaded on a PC with a 4-channels full-duplex sound board (Wave/4). In its multitrack mode, CoolEditPro is capable of synchronous playback and record, and thus maintains the absolute phase information between the input and output of the system under test. This makes it possible to generate a multichannel excitation signal which automatically feeds the four sections of the sound system in sequence, while the 4 microphone signals are simultaneously sampled. After this acquisition phase (typically shorter than 1 minute), the sampled signals are processed through a specially developed multiple MLS deconvolver, which will be described later.

The excitation signal is in this case made of two stereo sound tracks. The first is played through one stereo port of the sound board, connected to the frontal loudspeakers, and the second sound track is played on the rear loudspeakers through the second stereo port. This way, no relay switcher is required, but it is needed that the 4 power amplifiers are perfectly matched.

The 2 input stereo ports are connected through proper calibrated preamplifiers with two binaural microphones, placed on dummy heads at the front and rear seat of the car.

Fig. 3 shows a global layout of the measurement system. Actually all these units are placed in a single case, from which a single power cable connects to the DIN connector of the sound system, so that the connection of the measurement system with the car is fast and easy.

The power amplifier, the microphone preamplifiers and the power supplies were built in the ASK laboratory, whilst the dummy head microphones are actually two Sennheiser MKE 2002. In the future, it is planned to substitute them with other dummy heads, as Sennheiser does not produce them anymore.

After the deconvolution is performed, the results are 2 standard sound files (WAV format) containing, for each dummy head, the 4 binaural impulse responses of the 4 sections of the sound systems.

These results files can therefore be processed with an integrated analysis software, made specifically for this purpose, which also controls CoolEditPro during the acquisition. This

way, the 1/3 octave spectra and the other objective criteria can be displayed at will and stored to disk.

#### **4. Software Implementation**

A dedicated software was developed (in Visual Basic) for automating the measurement and for processing the results. This program takes control of CoolEdit PRO, and interacts with two additional modules specifically developed inside it for generating multiple repetitions of the MLS signal and for deconvolving the system responses.

As soon as the main program is launched, a small start-up mask is displayed, as shown in fig. 4. If the user chooses to start a new measurements, a second masks appears, where the user can choose the number of dummy heads to be employed (actually 1 or 2, but in future they could become 4, if an 8-channels sound card is used). For each dummy head, the user has to choose the name of the .WAV file in which the result will be saved, as shown in fig. 5.

After the second mask is closed, CoolEdit PRO is opened just below the first mask, and it is placed in multi-track mode, with 4 stereo waveforms displayed. On the upper two waveforms the excitation signals are loaded from disks: 32 repetitions of the MLS sequence of order 15 are subsequently placed on the first left and right channels (front), and then on the second left and right channels (rear), so that only one channel is excited at each time. The whole excitation sequence is thus  $32 \cdot 16384 \cdot 4$  samples, which at 44.1 kHz gives a total length of 47.5 s.

When the files are properly loaded, the recording of the other two stereo tracks begins. CoolEditPro automatically plays the first two tracks, which are not checked for recording. During the recording, a real-time display of the signals being recorded is given, as shown in fig. 6.

As soon as the recording ends, the Visual Basic program switches CoolEditPro in Single Waveform mode. Each dummy-head recording is processed through the Multiple Deconvolver module, as shown in fig. 7. The first of the 32 repetitions of the MLS sequence is discarded, as during its playback the system has not reached the steady state yet, and then the subsequent 31 repetitions are analyzed; this is repeated 4 times, corresponding to the excitation of the 4 loudspeaker sections. The deconvolver places the results in the Windows Clipboard, from where CoolEditPro retrieves them into a new waveform file, which is saved with the already assigned name, always under control from the Visual Basic program. Fig. 8 shows the results of a typical measurement inside a car: for each dummy head position, 8 impulse responses are obtained.

After the measurements are completed, CoolEditPro is closed, and the Visual Basic program goes into its post-processing mode (which could be entered also directly, pressing the proper button on the first mask).

The first dummy head response is displayed in the upper part of the screen. The user can choose which part to analyze simply by clicking over it, or pressing the selector buttons above. Through them, also the combined responses can be computed, selecting two of the 4 loudspeakers, or all four. It must be noted that the summation between the responses of the corresponding front and rear loudspeakers is made as pressure summation (because usually the same excitation signal is applied to the front-left and to the rear-left loudspeakers). Instead, the left and right sections of the system are summed energetically, because it is assumed that the two channels are almost uncorrelated.

As shown in figs. 9 and 10, the spectra of the selected responses are displayed either in narrow-bands or 1/3 octave bands. The vertical axis is calibrated in dB-SPL.

The excitation MLS signal is inherently white, so no frequency equalization is required when looking at the narrow, constant bandwidth spectrum. Instead, with 1/3 octave spectra, the “whiteness” of the excitation signal causes a systematic increase of high-frequency levels, with a slope of 3 dB/octave. This effect is compensated for by the software, which leaves untouched the SPL value at 1 kHz, adjusting the others so that the global shape remains the same as for the narrow-band display. This means that the measured response can be compared both with an FFT spectrum obtained with white noise excitation, and with an 1/3 octave spectrum obtained with pink noise excitation having the same SPL at 1 kHz.

The excitation signal is amplitude controlled, so that the total RMS voltage at the amplifier output is exactly 2V on a calibrated 4  $\Omega$  resistive load. This gives a nominal power of 1 W broadband white. This makes it possible to compare different sound systems not only in terms of spectral flatness, but also of absolute SPL produced. Thus, the measurement results carry an information not very dissimilar to the concept of Strength for concert halls, with the difference that in this case the measurement takes into account the efficiency of the loudspeakers and of their coupling with the car compartment.

The displayed spectra can be saved to ASCII files, or exported through the Windows Clipboard both in graphical and numerical form. It must be noted that in narrow-band mode a 16384-point FFT is made, but for reducing the number of data fields in the saved or exported files, a logarithmic frequency resampling is done, giving a total of just 512 spectral bands. A smoothing/interpolation algorithm ensures that these 512 values contain almost the whole information of the narrow-band spectrum.

## **5. Verification and calibration**

In this section some experimental results, obtained during the initial tests on the new measurement systems, are presented. First the performance of the multichannel sound board were checked. The frequency response and the cross-talk between channels were measured playing a order-16 MLS signal through 4 cables connecting the outputs with the inputs. Fig. 11 shows the flatness of the frequency response, and fig. 12 the signal separation between adjacent channels. As it can be seen, the flatness is within +/- 0.5 dB from 20 Hz to 20000 Hz, and the signal separation is better than 85 dB up to 3 kHz, then it reduces progressively to 67 dB at 20 kHz.

Also the measurement of the distortion gave incredibly good results, as reported in fig. 13. This measurement was again made employing the sound board both for creation of the excitation signal and for sampling its own output, and thus the measurement takes into account for both the output and input stages of the board. The THD value, for 1 kHz excitation at 6dB below from the full scale, is less than 0.01 %, while THD+Noise is only slightly larger.

It must be noted that the above tests were previously made on other widely employed 16-bits boards, but the results were so bad that the whole project was in risk to be abandoned. It was discovered, for example, that although the full-duplex operation is apparently supported by the most diffused boards, actually it is impossible to make simultaneous 16-bit record and playback on them, probably due to a bug in the software drivers.

The incredibly good performances of the low-cost 4-channels soundboard were the key for obtaining effective measuring performances within the strict acceptance limits that were posed for this project.

Nevertheless, also the analog parts of the equipment had to be checked. So a complete measurement setup was created, and compared with other three existing systems: a MLSSA

system, a CLIO system and a B&K type 2012 sound analyzer. The first two are MLS systems, while the third uses a multi-frequency sine excitation signal.

Fig. 14 shows the comparison of an actual measurement performed with all the 4 systems. As it can be seen, the new system (provisionally indicated as PSA-test) is always between the other three, and exhibits smoother and cleanest response. At low frequency the other two MLS systems give strange peaks and valleys, while the new measurement systems always stays very close to the reference B&K analyzer.

A further validation of the post-processing routines was made by comparing the computed spectra with a direct transfer-function measurement obtained with the SoundTechnology SpectraLAB program, which was employed for analyzing a two-channel waveform obtained assembling the excitation MLS signal on the left channel and a microphone response on the other. Fig. 15 shows the comparison of these two spectra, and again the difference was less than  $\pm 1$  from 90 Hz to 20 kHz. At very low frequency, the FFT-based transfer function computed by SpectraLab shows higher values than the new MLS measurement systems: this was explained thanks to the better noise immunity of the MLS technique, which was able to reject the low frequency noise which penetrates in the anechoic room through the door.

The final step was the calibration of the microphones for true SPL readings. This was accomplished easily, by placing a standard 94 dB, 1 kHz reference source on each microphone. After having manually adjusted the microphone preamplifiers so that this 94 dB signal was around 16 dB lower than the sound board overflow limit, a 30s long sound sample was taken from each of them and analyzed through SpectraLAB. The RMS amplitude of the signal in the 1 kHz 1/3 octave band was thus obtained (in dB re FullScale), and manually saved in the .INI file containing the calibration data. A check of the calibration stability was made after one month, and it resulted that the maximum variation was +0.3 dB for one microphone. The long-term stability (1 year) has not been checked yet...

An automated calibration procedure is under development at the time of writing, for avoiding the need to use the external SpectraLAB software.

## **6. Measurements on car systems**

The system was operational for only two weeks at the time of writing, so only a very little number of tests on car sound systems were done. Fig. 16 shows the comparison between the global response of two cars of different makers: it is quite clear that the car A has a sound system which is louder than car B, but this happens at the expense of the spectral regularity and extension. Not surprisingly, also the engine and tyre noise level inside the car A is louder than in car B.

But looking at the impulse response in time domain, as reported in fig. 17, it appears that in car A there is a longer reverberation time, and the acoustic modes are weakly damped. Instead, in car B the response is shorter and smoother, and this explains the lower SPL values.

It was concluded that the sound system of car A should be quite unpleasant compared to the one in car B, as the S/N ratio is almost the same, and the extra loudness of system A is caused mainly from undamped resonances and not from higher efficiency.

For confirming such an hypothesis, without the bias caused by other not acoustical effects which cannot be avoided making the subjects to seat inside the cars, the measured impulse responses were employed as numerical filters for producing audible simulations of the sound field. The technique for these virtual reconstructions was already presented in [7,8,9].

Two music samples were thus produced, which were presented to 5 subjects. They had simply to state what of the two sounds they appreciated more (simple preference test), and 4 of them choose car A, whilst the fifth subject was in doubt.

## **7. Conclusions**

A new measurement system for the complete characterization of car audio systems has been developed. This was possible thanks to the simultaneous record and sampling capability of the multitrack sound editor program CoolEditPro, and to the excellent analog and digital performances of the Wave/4 sound board.

The measurements taken in comparison with already existent instruments have shown that the new method is at least as reliable and accurate as the others, and gives great benefits in terms of ease of use and automation of the measurements. Furthermore, the post-processing tools allow for a simple visualization of the system's behavior, although more detailed analysis is always possible, being the results saved in standard files which can be processed from any other analysis package.

The measurement results can also be used for the virtual reconstruction of the sound field inside the car, both for headphones and loudspeakers playback: this system was already checked in the past with singularly measured impulse responses, but now the implementation of a virtual reconstruction becomes a matter of a few seconds, because a single results file contains the whole set of measured impulse responses, ready for being inserted in the convolution program.

The work will prosecute with the goal of increasing the number of measurement channels, by using two synchronized soundboards or a professional, 8-channels soundboard. Furthermore, an automated calibration procedure is under development, and other kinds of dummy heads will be checked.

The system can already be employed for measurements not based on the binaural technology, making use of a Soundfield three-dimensional microphone, through which 4-channels, B-format impulse responses can be measured. In the future, the whole measurement and virtual playback system will be upgraded to such an Ambisonics-like technique, which will make it possible to present the virtual reconstructions to moderately-sized groups of listeners inside a proper 3D listening environment.

## **8. Acknowledgements**

Mr. Daniel Turmin from PSA Auto – France is acknowledged as the inspirator of the new measurement system, and for useful discussion about the goals and the user's interface.

David Johnston, developer of CoolEditPro, is acknowledged for his excellent software, which was kindly made available free for this research.

This work was supported through a research convention between ASK Industries and the University of Parma, with contribution from PSA Auto.

## 9. References

- [1] H. Alrutz, M.R. Schroeder, "A fast Hadamard transform method for evaluation of measurements using pseudorandom test signals" Proc. of 11<sup>th</sup> International Congress on Acoustics, Paris, 6, pp. 235-238.
- [2] Y. Ando, *Concert Hall Acoustics*, Springer-Verlag, Berlin 1985, appendix
- [3] W.T. Chu, "Impulse response and Reverberation Decay measurements made by using a periodic pseudorandom sequence", *Applied Acoustics*, vol. 29, pp. 193-205 (1990).
- [4] J. Vanderkooy, "Aspects of MLS measuring systems", *JAES* vol. 42, n. 4, 1994 April, pp. 219-231.
- [5] E. Mommertz, S. Muller, "Applying the inverse fast Hadamard transform to improve MLS-measurements", Proc. of ICA95 (International Conference on Acoustics), Trondheim (Norway) 26-30 June 1995, vol. IV, pp. 127-130.
- [6] A. Farina, F. Righini, "Software implementation of an MLS analyzer, with tools for convolution, auralization and inverse filtering", Pre-prints of the 103<sup>rd</sup> AES Convention, New York, 26-29 September 1997.
- [7] A. Farina, E. Ugolotti, "Subjective comparison of different car audio systems by the auralization technique", Pre-prints of the 103<sup>rd</sup> AES Convention, New York, 26-29 September 1997.
- [8]A. Farina, E. Ugolotti, "Subjective Evaluation Of The Sound Quality In Cars By The Auralisation Technique", Proc. of 4th International Conference and Exhibition Comfort in the automotive industry - Bologna (Italy) October 2-3, 1997.
- [9]A. Farina, E. Ugolotti, "Subjective Evaluation Of The Sound Quality In Cars By The Auralisation Technique", Reproduced Sound 13 – Windermere (GB) October 23-25, 1997.



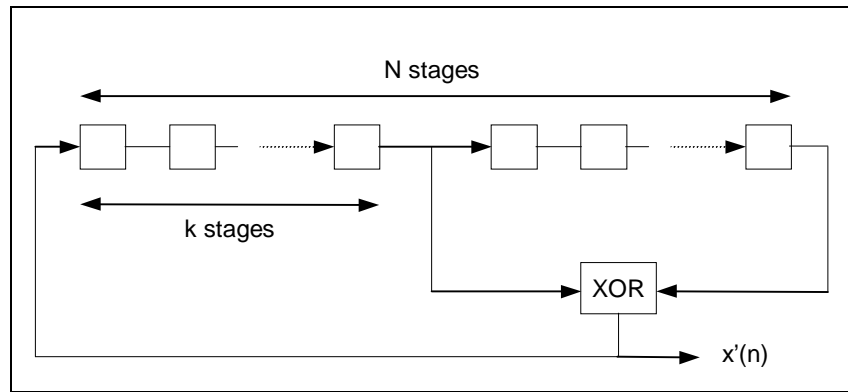

Fig. 1 – Shift register for the creation of the MLS signal

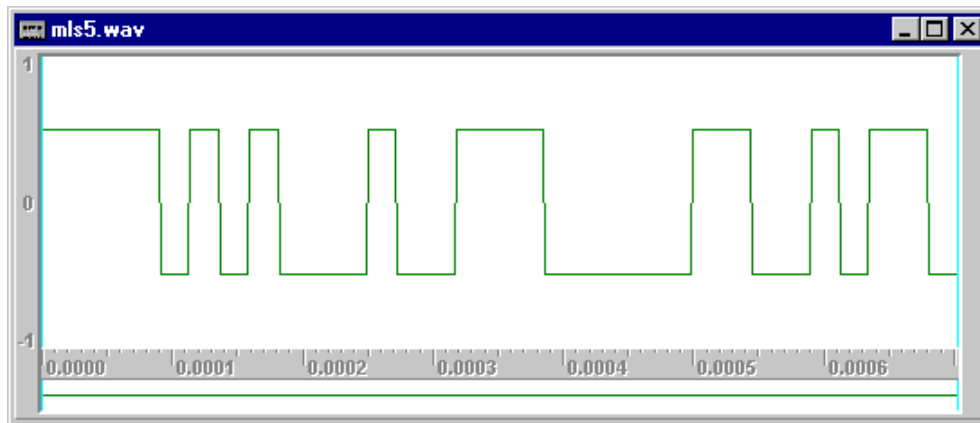

Fig. 2 – MLS sequence of order 5

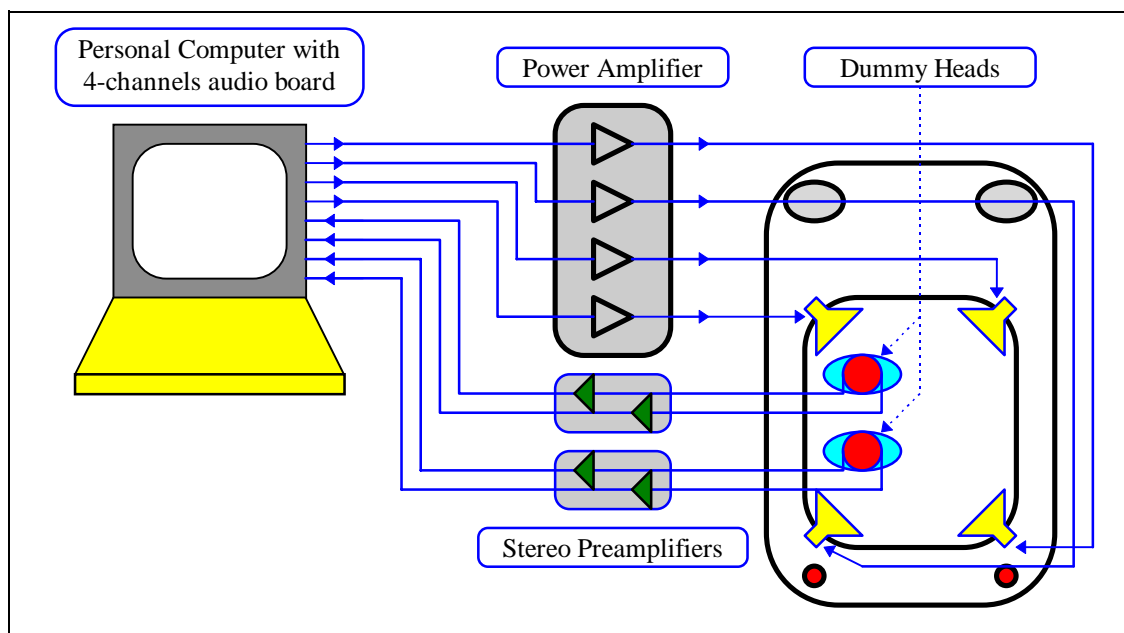

Fig. 3 - Layout of the measurement system

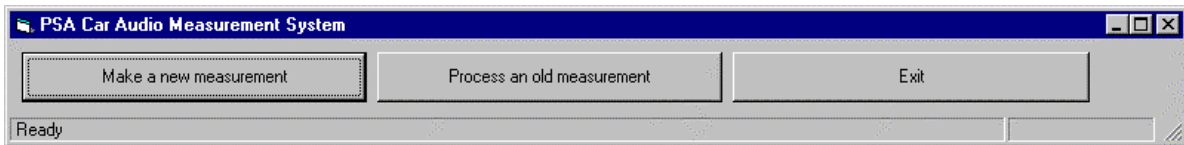

Fig. 4 - Initial mask of the PSA-test program

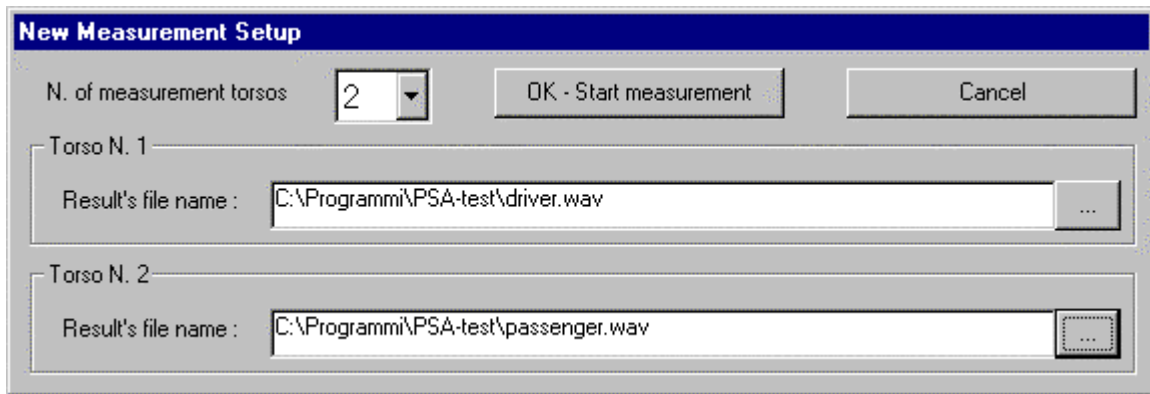

Fig. 5 - Assignment of the output file names

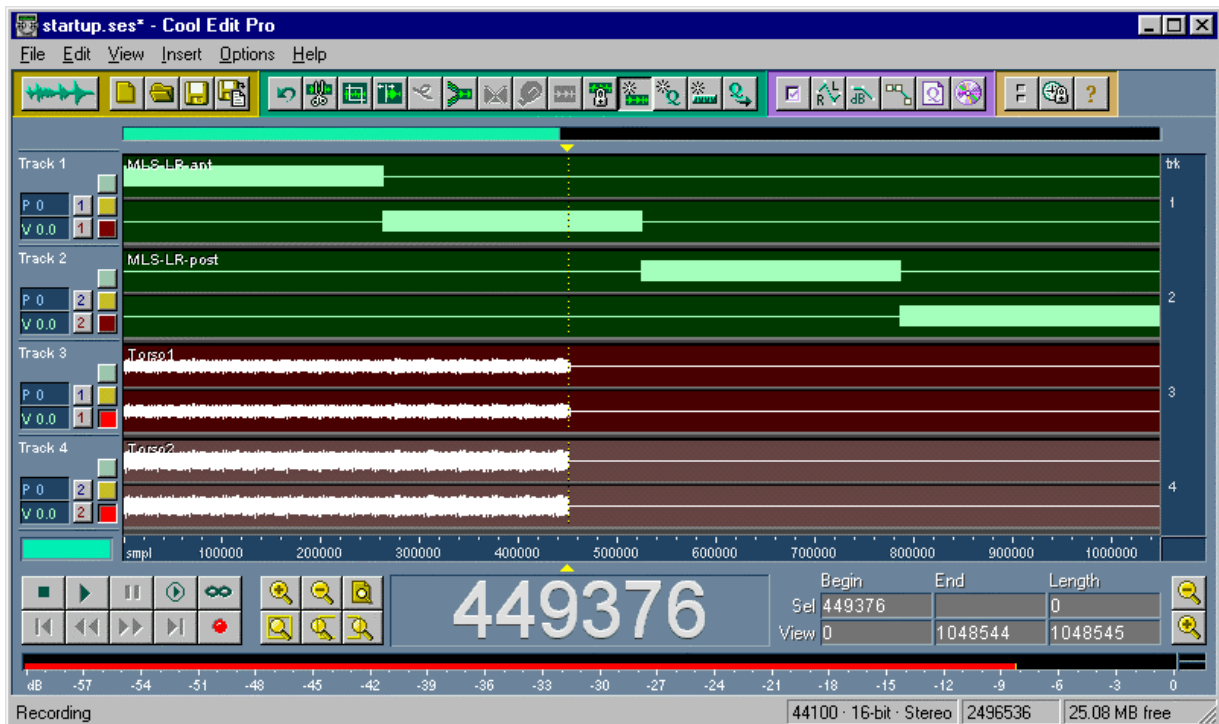

Fig. 6 – Cool Edit Pro during the simultaneous Playback & Record

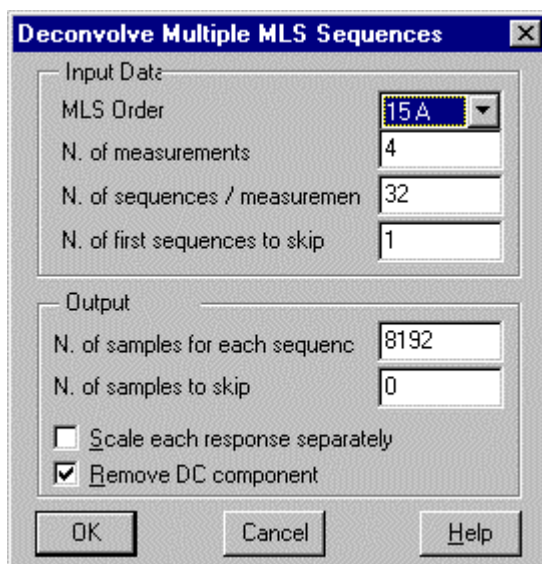

Fig. 7 - User's interface of the MLS deconvolution module

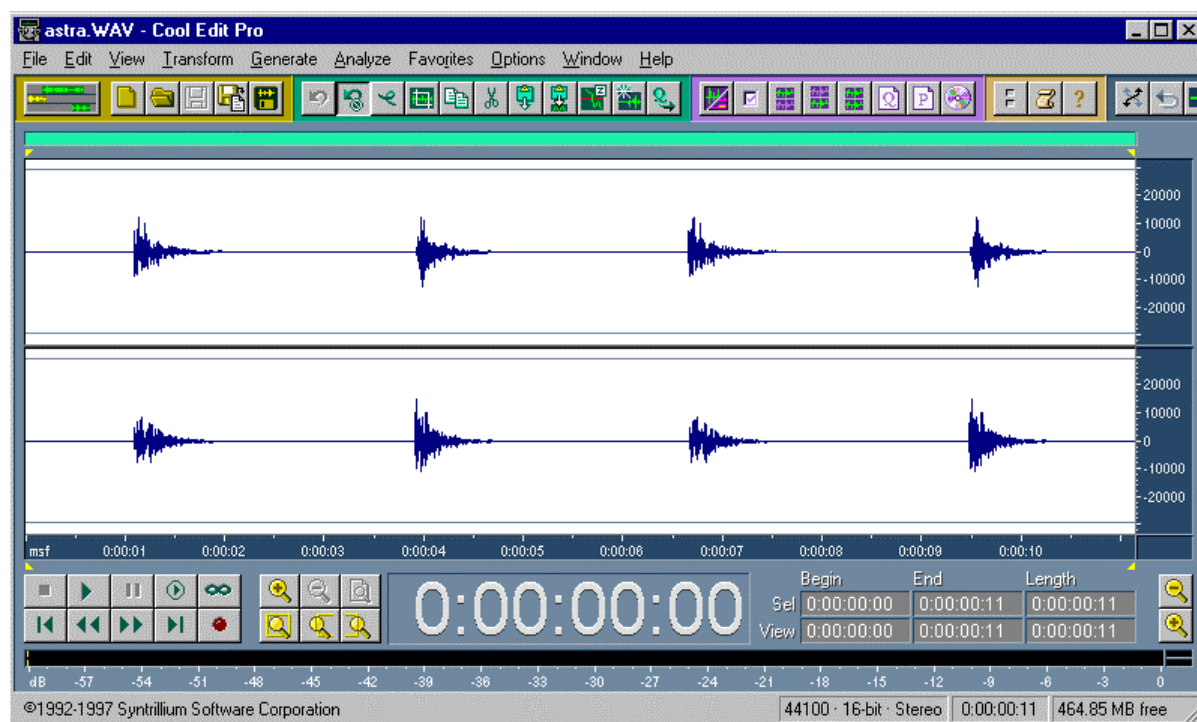

Fig. 8 - A typical measurement result inside a car

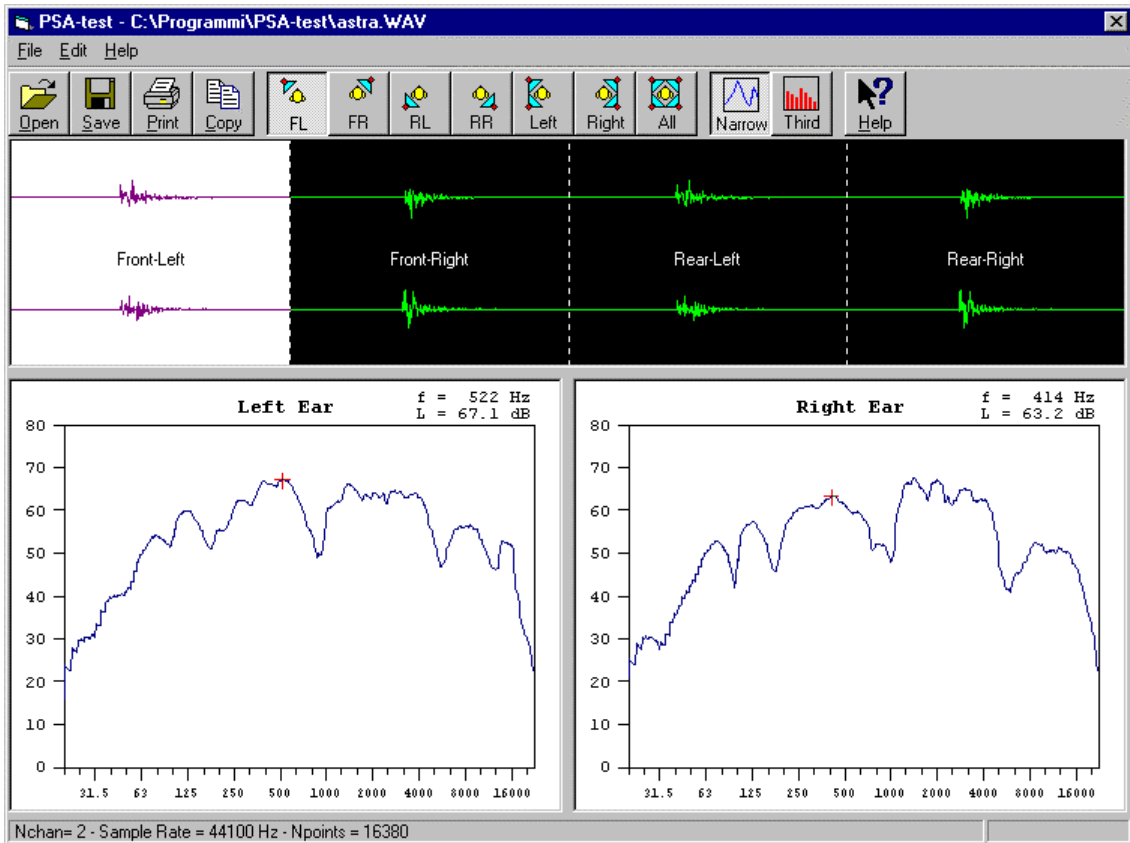

Fig. 9 - Post-processing window, narrow-band mode of a single loudspeaker

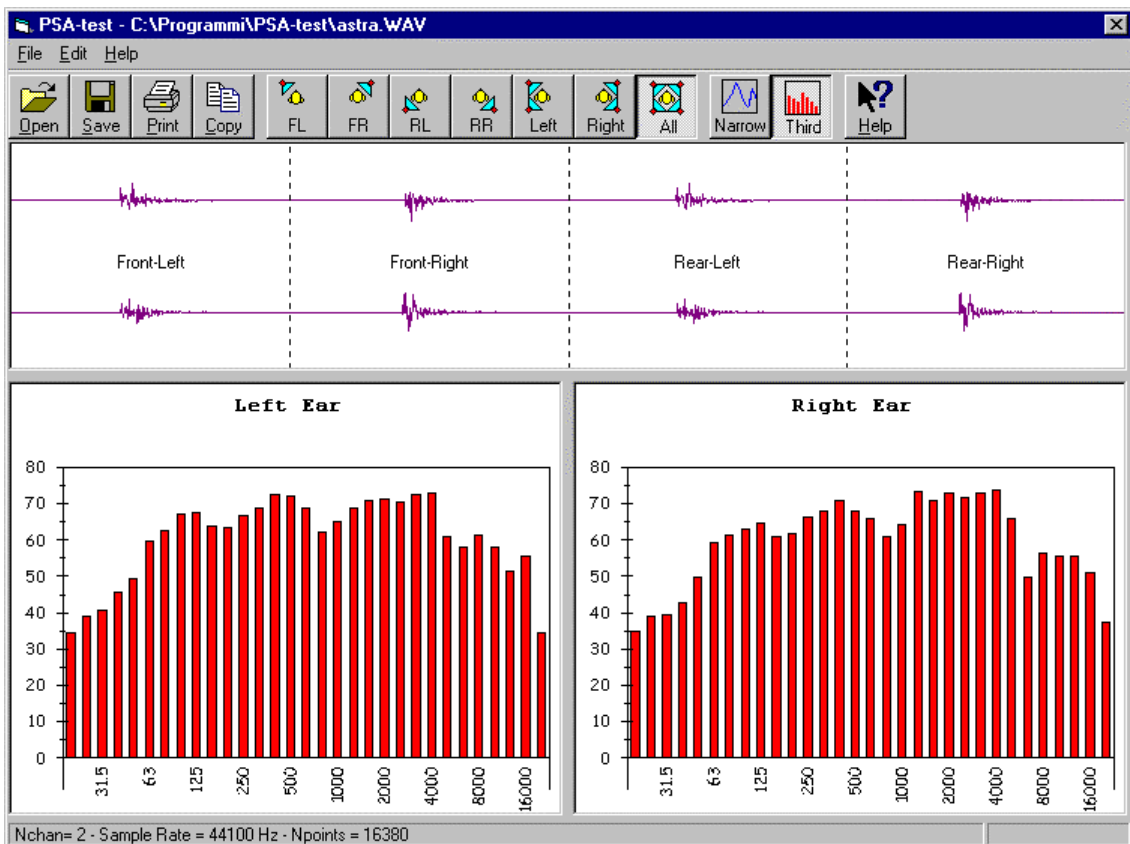

Fig. 10 - Post-processing window, 1/3 octave mode of all 4 loudspeakers

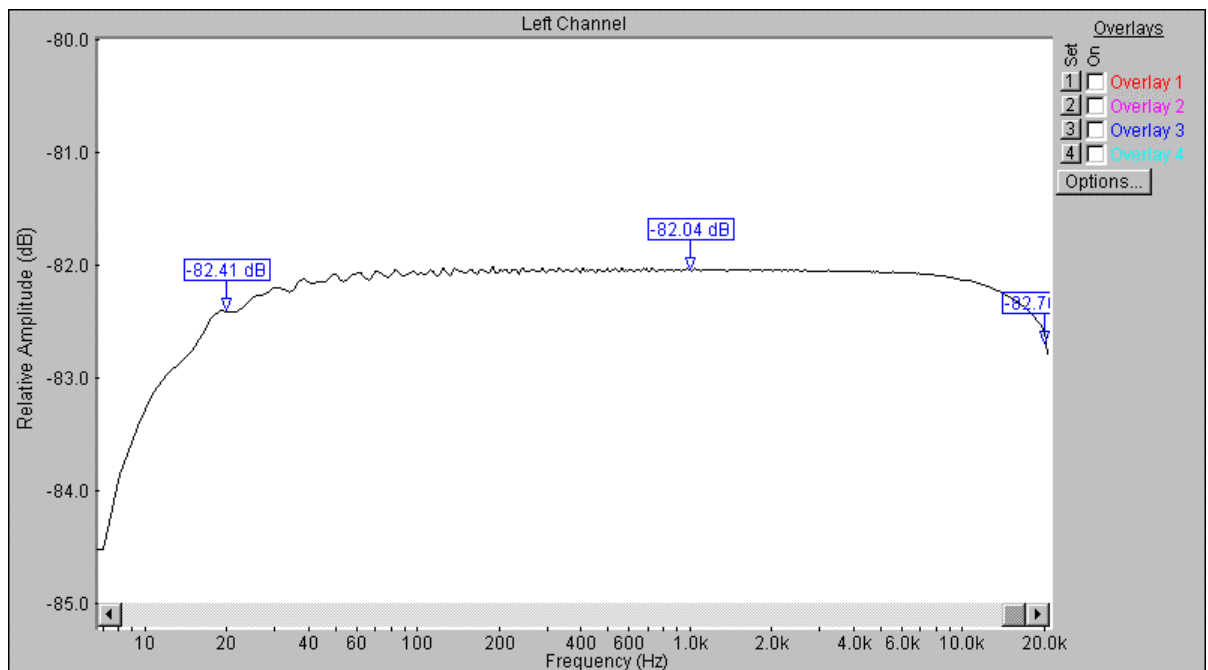

Fig. 11 - Frequency response of the Wave/4 board in simultaneous playback & record mode

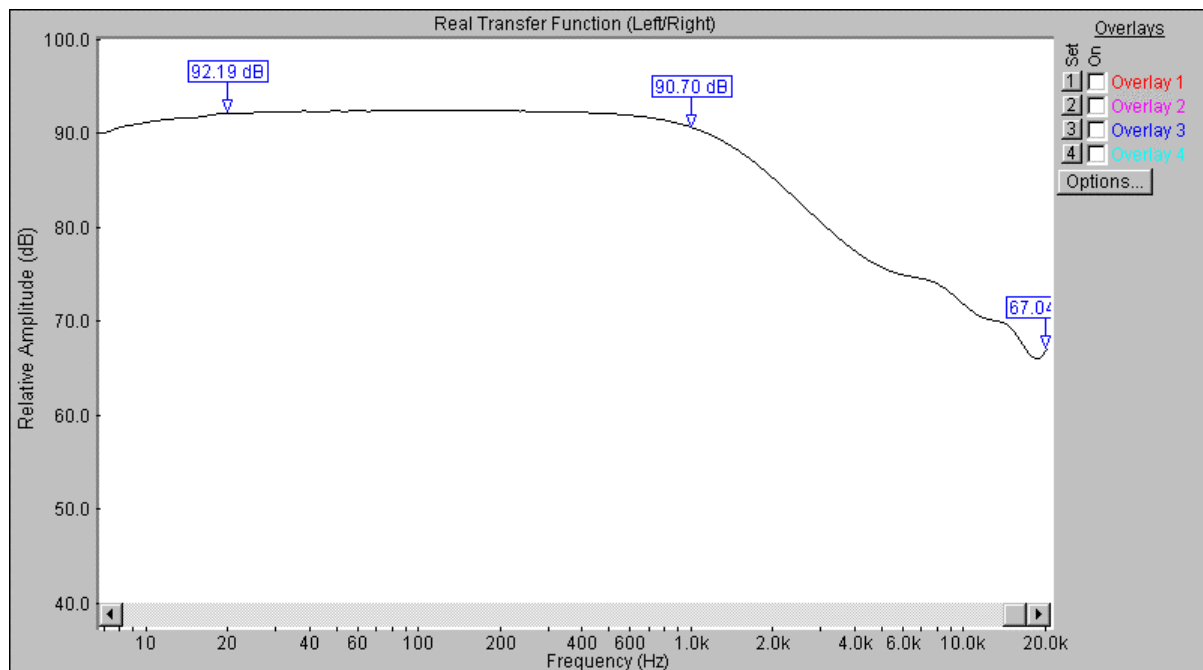

Fig. 12 - Channel separation between inputs N. 1 and 2

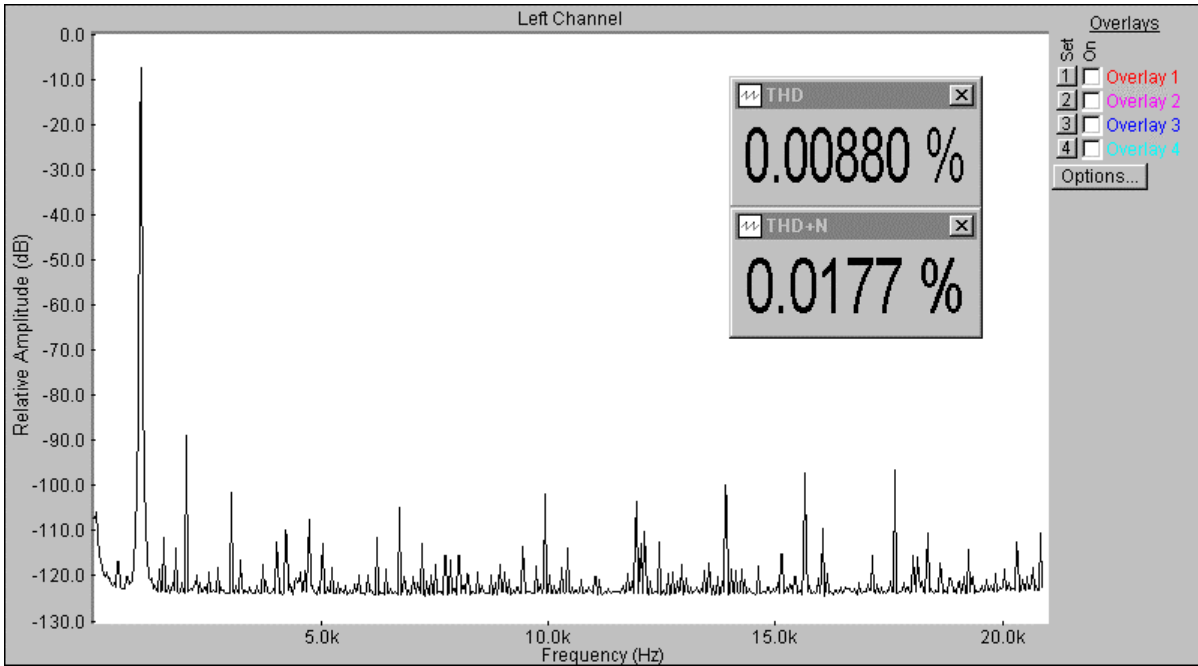

Fig. 13 - THD and THD+NOISE with an 1 kHz tone at - 6 dB  
Simultaneous Playback & Record

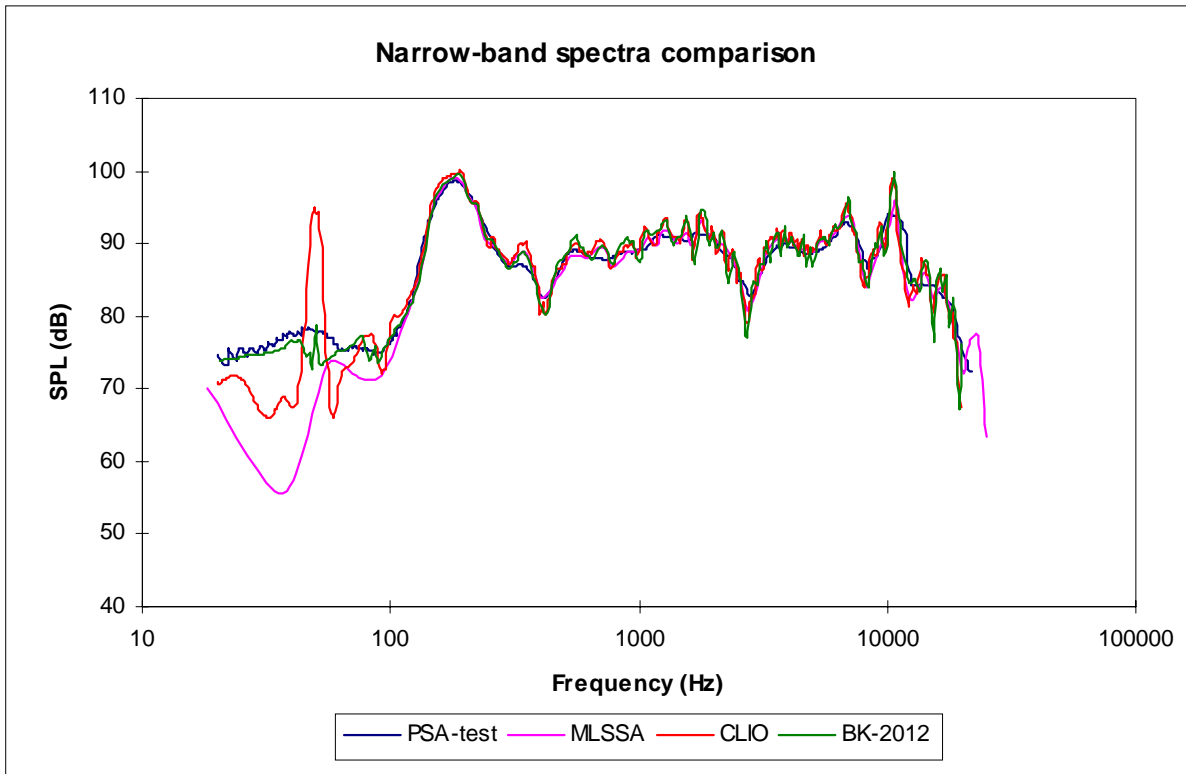

Fig. 14 - Comparison between narrow-band loudspeaker responses

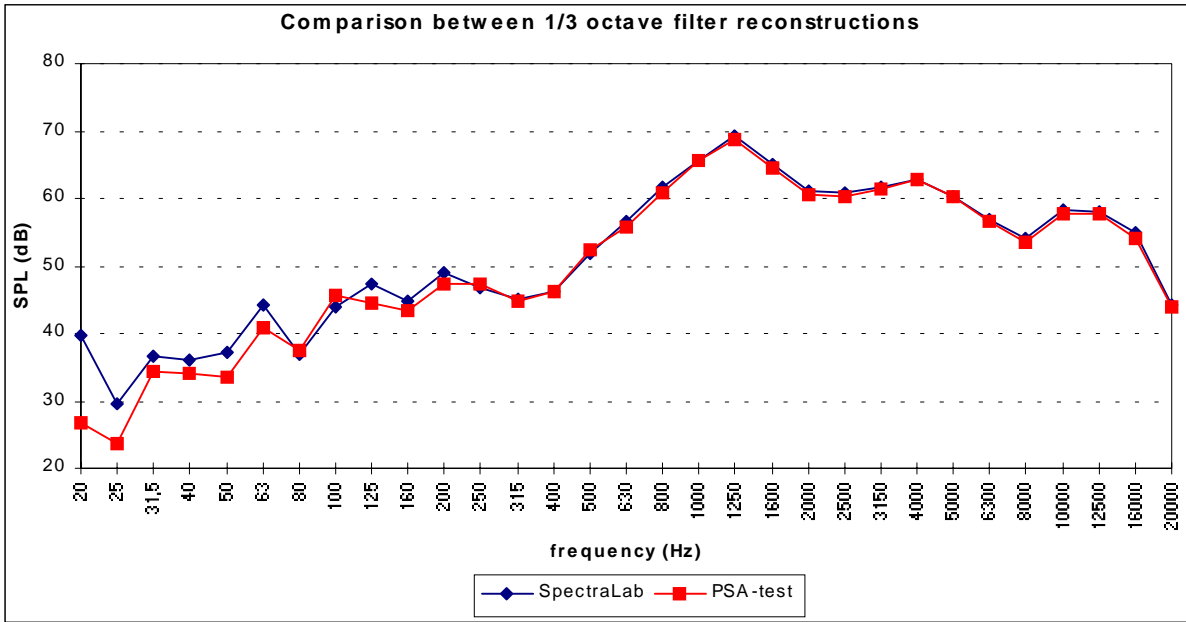

Fig. 15 - Comparison between MLS and real-time Transfer Function measurements

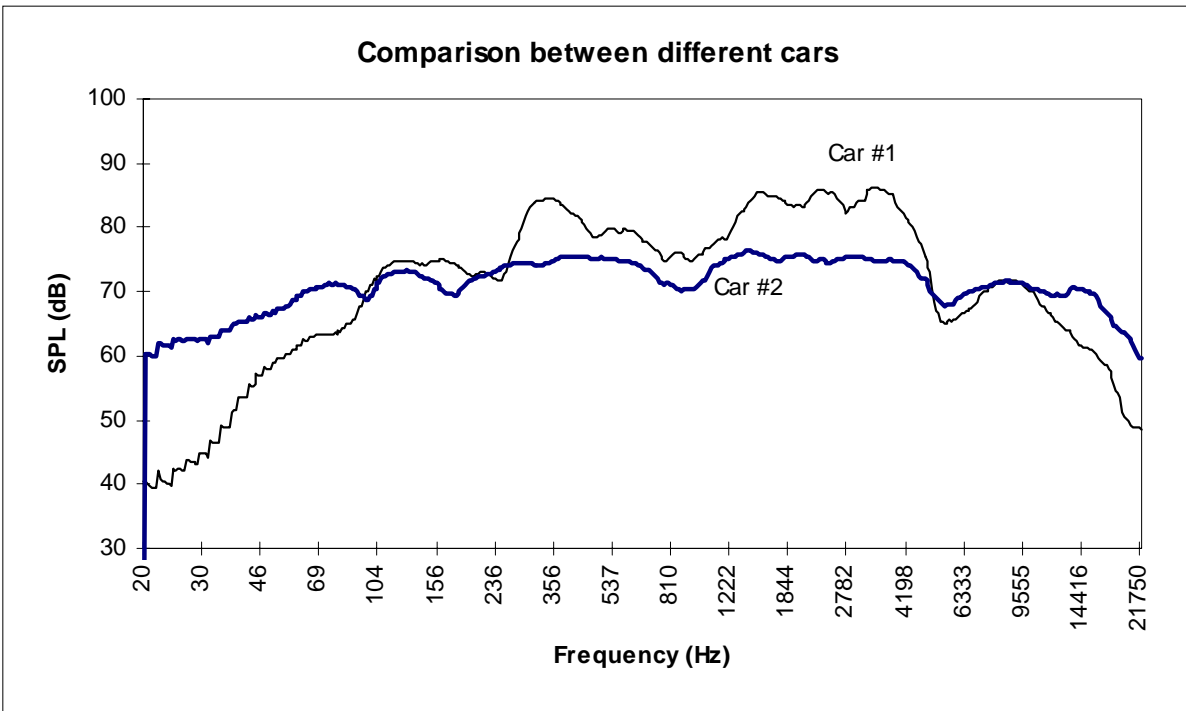

Fig. 16 - Comparison between narrow-band spectra of 2 different cars.

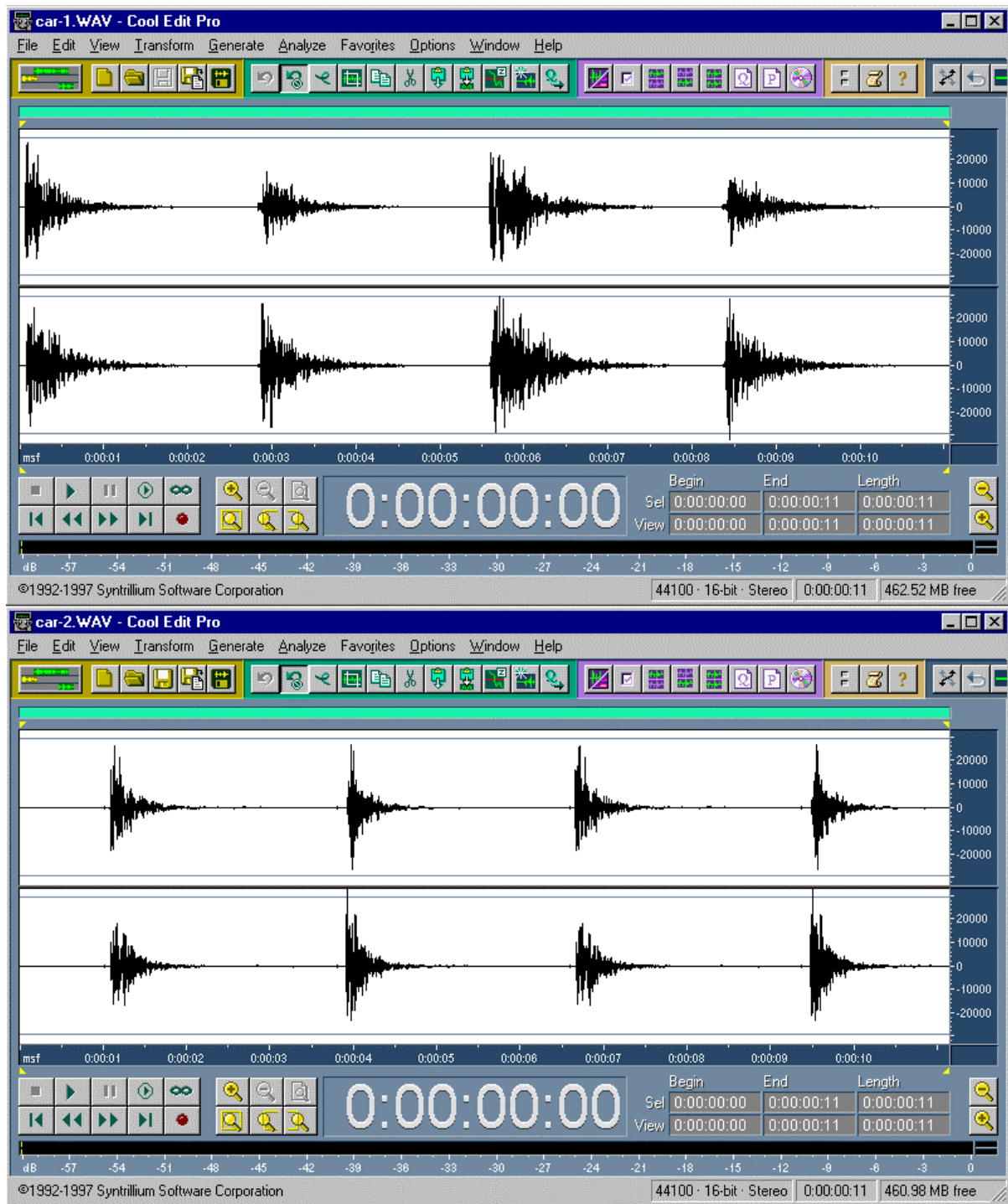

Fig. 17 - Impulse responses in cars #1 (above) and #2 (below)